



Guéridon  
Gamme 4000  
4000

CARINA  
Medical



CE  
ISO 9001  
ISO 13485

## DESCRIPTION TECHNIQUE

- Meuble bois stratifié blanc
- Equipé de 3 tiroirs coulissants et galerie sur 3 côtés
- Pied oblique acier peint époxy, coloris gris clair (RAL 7035) en standard
- Sur 4 roulettes, diam. 50mm

## DIMENSIONS

- Largeur 40cm
- Longueur 60cm
- Hauteur 87,5cm
- Poids max supportable : 50kg

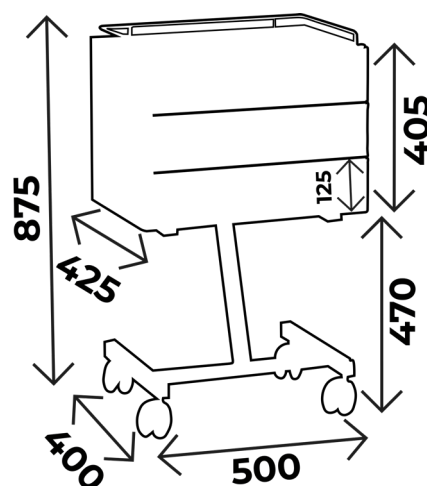

### Vous aimerez aussi :

Réf. **4100** : Idem 4000 mais pied central 5 branches













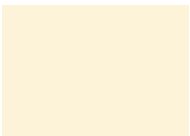

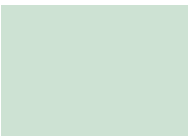

### À SAVOIR

- ✓ Guéridon livré démonté
- ✓ Délai : 15 jours à réception commande
- ✓ Garantie : 2 ans

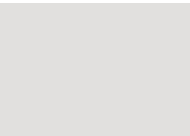
# COLORIS PIÈTEMENT

Toute la gamme 4000 a un piètement coloris gris clair (RAL 7035) en standard  
Possibilité de changer le coloris de piètement **sans plus value**

## *Piètement Peinture EPOXY*

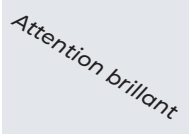
				
<b>RAL 9003</b>	<b>RAL 1013</b>	<b>RAL 1015</b>	<b>RAL 6019</b>	<b>RAL 6033</b>
				
<b>RAL 6000</b>	<b>RAL 5017</b>	<b>RAL 5002</b>	<b>RAL 5000</b>	<b>RAL 7035</b>
				
<b>RAL 7016</b>	<b>RAL 9005</b>	<b>RAL 1018</b>	<b>RAL 3020</b>	<b>RAL 3003</b>
				
		<b>ARGENT</b>		



## GUIDE D'ENTRETIEN

### **ENTRETIEN QUOTIDIEN**

- Piètement : nettoyage à l'eau savonneuse uniquement (solvants proscrits) sans matière abrasive

### **GARANTIE**

- 2 ans



**CONTACT**

**CARINA**  
*Médical*

Parc d'entreprises Visionis  
278 rue de l'industrie  
01090 GUÉREINS- FRANCE

**SERVICE COMMERCIAL**

Tél: +33(0)4 74 66 69 49  
Fax: +33(0)4 74 66 69 50  
[commercial@carinamedical.com](mailto:commercial@carinamedical.com)