



Divan d'examen hauteur fixe

Gamme 326

326 03T

CARINA
Medical



CE
ISO 9001
ISO 13485

DESCRIPTION TECHNIQUE

- Divan d'examen à hauteur fixe, 2 parties
- Réglage de la tête par vérin à gaz
- Sellerie tendue plate de bonne densité 30kg/cm², non-feu classée M1, épaisseur 8cm
- Equipé d'un porte-rouleau pour drap d'examen côté pied
- Piètement acier peint époxy, coloris gris clair (RAL 7035) en standard

DIMENSIONS

- Largeur 70cm
- Hauteur 80cm
- Capacité de charge : 130kg

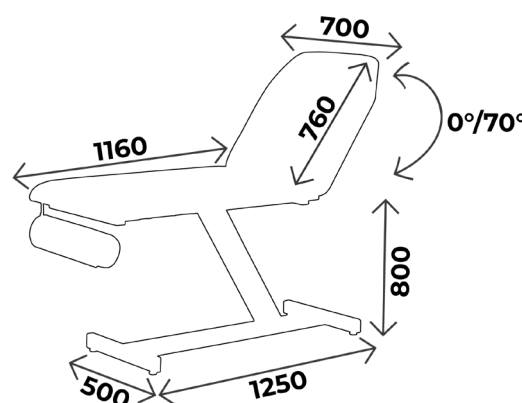

Vous aimerez aussi :

Réf. **326 03TB** : Idem 326 03T mais hauteur 65cm

Réf. **326 01T** : Idem 326 03T mais largeur 60cm

Réf. **326 01TB** : Idem 326 03T mais largeur 60cm et hauteur 65cm



À SAVOIR

- ✓ Délai : 15 jours à réception commande
- ✓ Garantie : 5 ans (1 an pour la sellerie)

ACCESSOIRES



ACC 999
Support roulettes escamotables
diam. 50mm
pour 326 fixe, 2 parties



ACC 990
Jeu de 4 roulettes à frein
diam. 125mm



ACC 76B
Étau unitaire diam. 14mm



ACC 76
Paire d'étaux pour fixation
gouttières et étriers diam. 14mm



ACC 76C
Étau unitaire
pour tige porte-sérum diam. 16mm



ACC 32012
Tige porte-sérum diam. 16mm
2 crochets plastiques, sans étau

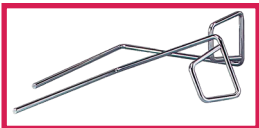

ACC 105
Jeu d'étriers inox standard
diam. 14mm, sans étau



ACC 964
Jeu de repose jambes noir,
sur rotule mousse polyuréthane,
diam. 14mm, sans étau



SLFEMIREPOSE
Housse prélude pour repose
jambes (ACC964), l'unité



ACC 514-UNIVERSE
Protection plastique transparent
universelle



ACC 110POLY
Gouttière prise de sang
polyuréthane avec ferrure
Sans étau, l'unité



ACC 110
Gouttière prise de sang
Avec ferrure, sans étau, l'unité

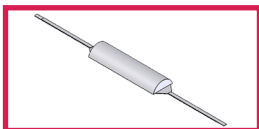

ACC 32670
Tête 1/2 lune largeur 70cm



ACC TETERGO
Tête ergonomique amovible



ACC 832
Trou visage avec bouchon



ACC BARRILIT326A
Paire de barrières de lit
escamotables
pour 326, 2 parties

COLORIS SELLERIE

Sellerie non-feu
classée M1

Pour les coloris de sellerie, vous avez le choix entre la gamme Classique et Urban
Attention ! coloris Urban **avec plus value**

Revêtement : Sellerie Gamme Classique

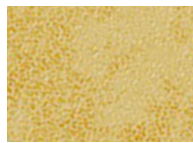

Arno



Garonne



Potomac

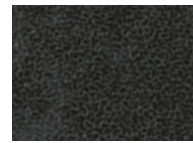

Amour

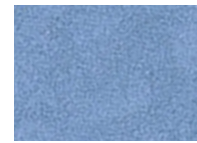

Mississippi

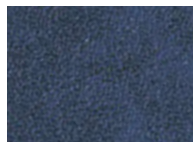

St Laurent

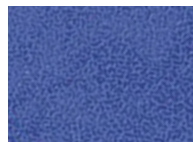

Rhône

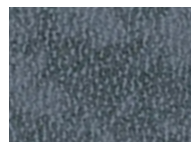

Missouri



Seine

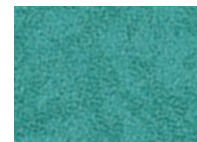

Amazone

Revêtement : Sellerie Gamme Urban



Abysse



Cendre



Origan



Géranium

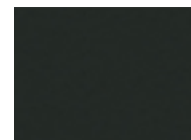

Réglisse



Prune

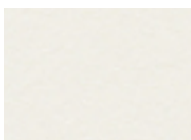

Perle

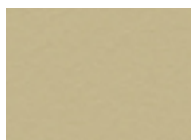

Ficelle



Terre



Béton

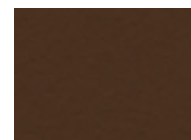

Chataigne

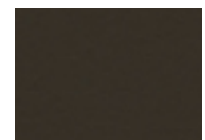

Chocolat

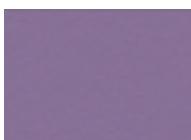

Pensée



Pétrole



Turquoise



Granny



Absinthe



Ananas



Orange



Fuschia











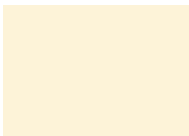

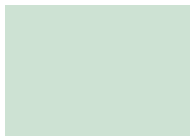

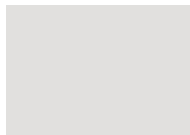

Tomate

COLORIS PIÈTEMENT

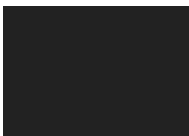
Toute la gamme 326 est proposé en coloris (RAL 7035) en standard
Possibilité de changer le coloris de piètement **sans plus value**

Piètement Peinture EPOXY

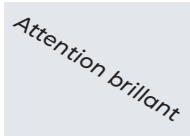
				
RAL 9003	RAL 1013	RAL 1015	RAL 6019	RAL 6033
				
RAL 6000	RAL 5017	RAL 5002	RAL 5000	RAL 7035
				
RAL 7016	RAL 9005	RAL 1018	RAL 3020	RAL 3003
				
		ARGENT		



GUIDE D'ENTRETIEN

ENTRETIEN QUOTIDIEN

- Sellerie : nettoyage à l'eau savonneuse uniquement (solvants proscrits), peut être désinfecté avec des produits tels que Phagosept Spray, Salvanios pH10 à 0,75% et Anios Surfaces Hautes, sans matière abrasive
- Piètement : nettoyage à l'eau savonneuse uniquement (solvants proscrits) sans matière abrasive

GARANTIE

- Châssis : 5 ans
- Sellerie : 1 an



CONTACT

CARINA
Médical

Parc d'entreprises Visionis
278 rue de l'industrie
01090 GUÉREINS- FRANCE

SERVICE COMMERCIAL

Tél : +33(0)4 74 66 69 49
Fax : +33(0)4 74 66 69 50
commercial@carinamedical.com